

Guide bearing LF20

- Guide bearing for trolley construction
 - Guiding via guide rod
 - Rollers with ball bearings, permanently lubricated
 - Lubricating felts with guide rod lubrication reservoir
 - Play-free roller adjustment via eccentric bolts
-
- Replacement of the lubricating felts possible from rear in installed state
 - Supporting bearing for brackets for bearing off-center forces
 - Guide rail to hold supporting bearings

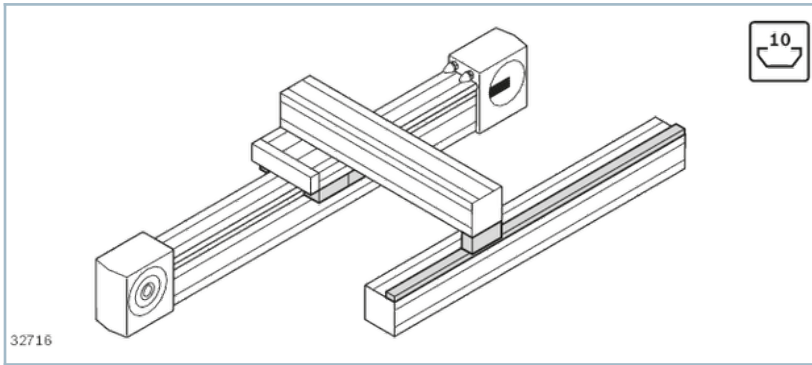





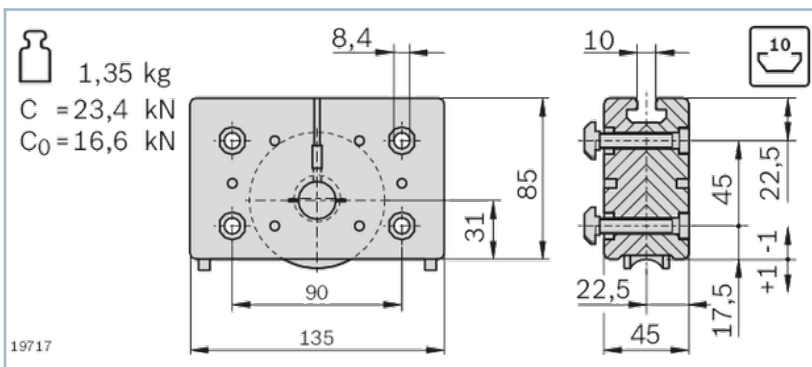





Product description



Dimensions



Delivery notes

FS5	FS6	FS7	FS8	FS9
 <p>DIN 7984 M12x40</p>	 DIN 7984 M8x30  DIN 125 A8,4  	 DIN 7991 M8x30  	 <p>$\varnothing 18 \times 7$</p>	 <p>$\varnothing 10 \times \varnothing 5 \times 11$</p>
FS1				
 DIN 7984 M8x40  				

Ordering codes

	FS	No.
Guide bearing LF20	4xFS1	3842535663